

Mid Tower

# H100 TG

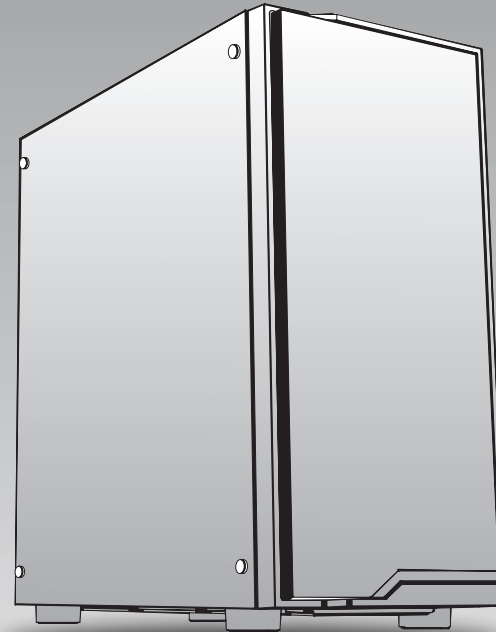

User's Manual  
Benutzerhandbuch  
Mode d'emploi  
Manual del usuario  
Manuale dell'utente  
Manual do Utilizador  
安裝說明書  
用戶手冊  
ユーザーズマニュアル  
Руководство пользователя  
kullanıcı elkitabı  
(EEE Yönetmeliğine Uygundur)  
คู่มือการใช้



© 2019 Thermaltake Technology Co., Ltd. All Rights Reserved. A-2019.04  
All other registered trademarks belong to their respective companies. [www.thermaltake.com](http://www.thermaltake.com)

# CONTENTS

## Chapter 1. Product Introduction

<b>1.1</b>	<b>Specification</b>	<b>02</b>
<b>1.2</b>	<b>Accessory</b>	<b>03</b>
<b>1.3</b>	<b>Warning and Notice</b>	<b>04</b>

## Chapter 2. Installation Guide

<b>2.1</b>	<b>Side Panel Disassembly</b>	<b>06</b>
<b>2.2</b>	<b>PSU Installation</b>	<b>07</b>
<b>2.3</b>	<b>Motherboard Installation</b>	<b>08</b>
<b>2.4</b>	<b>3.5" &amp; 2.5" HDD Installation</b>	<b>09</b>
<b>2.5</b>	<b>PCI Slot Usage</b>	<b>10</b>
<b>2.6</b>	<b>Air Cooling Installation</b>	<b>12</b>
<b>2.7</b>	<b>Radiator Installation</b>	<b>13</b>

## Chapter 3. Leads Installation

<b>3.1</b>	<b>Case LED Connection</b>	<b>14</b>
<b>3.2</b>	<b>USB 3.0 Connection</b>	<b>14</b>
<b>3.3</b>	<b>Audio Connection</b>	<b>14</b>

## Chapter 4. Other

<b>4.1</b>	<b>Thermaltake Power Supply Series (Optional)</b>	<b>20</b>
<b>4.2</b>	<b>Tt RGB Plus Ecosystem</b>	<b>21</b>











\*Picture for reference only

\*Information in the user manual is subject to change without notice

## Specification

Model	H100 TG
Case Type	Middle tower
Chassis Dimension (H*W*D)	416 x 210 x 454 mm (16.4 x 8.3 x 17.9 inch)
Side Panel	4mm Tempered Glass x 1
<b>Drive Bays</b>	
- Accessible	-
- Hidden	2 x 2.5" or 3 x 3.5"
Expansion Slots	7
Motherboards	6.7" x 6.7" (Mini ITX), 9.6" x 9.6" (Micro ATX), 12" x 9.6" (ATX)
I/O Port	USB 3.0 x 2, HD Audio x 1
Fan Support	Front: 3 x 120 mm, 2 x 140 mm Top: 2 x 120 mm, 2 x 140 mm Rear: 1 x 120 mm, 1 x 140 mm
Radiator Support	Front: 1 x 240 mm, 1 x 280 mm Top: 1 x 240 mm
Clearance	CPU cooler height limitation: <b>180 mm</b> VGA length limitation: <b>320 mm</b>

## Accessory

Figure	Parts Name	Q'ty	Used for
	Screw M3 x 5mm	9	Motherboard
	Stand-off #6-32 x 6mm	3	Motherboard
	Buzzer	1	Motherboard Alarm
	Stand-off tool	1	Stand-off
	Screw #6-32 x 6mm	4	Power Supply
	Screw M3 x 5mm	8	2.5"SSD
	Screw M3 x 5mm	4	2.5"SSD
	HDD/SSD Rubber	4	2.5"SSD/ 3.5"HDD
	Screw #6-32 x 10mm	8	3.5"HDD
	Screw T5 x 12mm	12	Case Fan
	Movable Tie	10	Cable Management

## Warning and Notice

### CPU Cooler Height Limitation

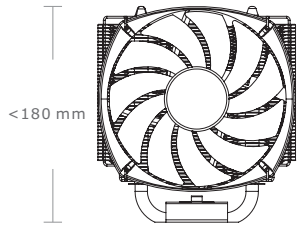

### VGA (Add-on card) Length Limitation

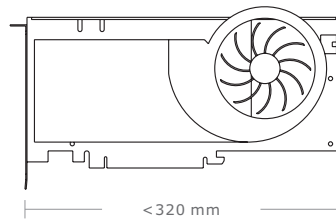

#### Warning!!

- Height limit for the CPU heatsink:  
The height limit for the CPU heatsink is 180 mm (7.1 inches).
- Length limit for the VGA (graphics card):  
The length limit for the VGA (graphics card) is 320 mm (12.6 inches).

#### Warnung!!

- Höhenbeschränkung für CPU-Kühler:  
Die Höhenbeschränkung für den CPU-Kühler liegt bei 180 mm (7,1 Zoll).
- Längenbeschränkung für die VGA (Grafikkarte):  
Die Längenbeschränkung für die VGA (Grafikkarte) beträgt 320 mm (12,6 Zoll).

#### Avertissement !

- Hauteur limite du dissipateur thermique du processeur :  
La hauteur limite du dissipateur thermique du processeur est de 180 mm (7,1 pouces).
- Longueur limite de la carte VGA (carte graphique) :  
La longueur limite de la carte VGA (carte graphique) est de 320 mm (12,6 pouces).

#### Precaución

- Límite de altura para el disipador de calor de la CPU:  
El límite de altura para el disipador de calor de la CPU es de 180 mm (7,1 pulgadas).
- Límite de longitud para la tarjeta gráfica (VGA):  
El límite de longitud para la tarjeta gráfica (VGA) es de 320 mm (12,6 pulgadas).

#### Attenzione!

- Limite di altezza per il dissipatore di calore della CPU:  
Il limite di altezza per il dissipatore di calore della CPU è 180 mm (7,1").
- Limite di lunghezza per la VGA (schede grafiche):  
Il limite di lunghezza per la VGA (scheda grafica) è 320 mm (12,6").

#### Atenção!!

- Limite de altura para o dissipador do CPU:  
O limite de altura para o dissipador do CPU é 180 mm (7,1 polegadas).
- Limite de comprimento para VGA (placa gráfica):  
O limite de comprimento para VGA (placa gráfica) é 320 mm (12,6 polegadas).

#### 警告！！

- CPU散熱器の高度限制:  
CPU散熱器の高度限制为180mm(7.1英寸)。
- VGA(顯示卡)的長度限制:  
VGA(顯示卡)的長度限制为320mm(12.6英寸)。

#### 警告！！

- CPU散熱器の高度限制:  
CPU散熱器の高度限制为180mm(7.1英寸)。
- VGA(显卡)的長度限制:  
VGA(显卡)的長度限制为320mm(12.6英寸)。

#### 警告

- CPUヒートシンクの高さ制限:  
CPUヒートシンクの高さ制限は180mmです。
- VGA(グラフィックスカード)の長さ制限:  
VGA(グラフィックスカード)の長さ制限は320mmです。

#### Внимание!

- Ограничение по высоте для радиатора ЦП.  
Ограничение по высоте для радиатора ЦП составляет 180 мм (7,1 дюйма).
- Ограничение по длине для платы VGA (графическая плата).  
Ограничение по длине для платы VGA (графическая плата) составляет 320 мм (12,6 дюйма).

#### Uyarı!!

- CPU ısı alıcısı için yükseklik sınırı:  
CPU ısı alıcısı için yükseklik sınırı 180 mm'dir (7,1 inç).
- VGA (grafik kartı) için uzunluk sınırı:  
VGA (grafik kartı) için uzunluk sınırı 320 mm'dir (12,6 inç).

#### คำเตือน!!

- ข้อจำกัดความสูงสำหรับฮีตซิงก์ของ CPU:  
ข้อจำกัดความสูงสำหรับฮีตซิงก์ของ CPU คือ 180 มม. (7.1 นิ้ว)
- ข้อจำกัดความยาวสำหรับ VGA (การ์ดแสดงผล):  
ข้อจำกัดความยาวสำหรับ VGA (การ์ดแสดงผล) คือ 320 มม. (12.6 นิ้ว)

## Side Panel Disassembly

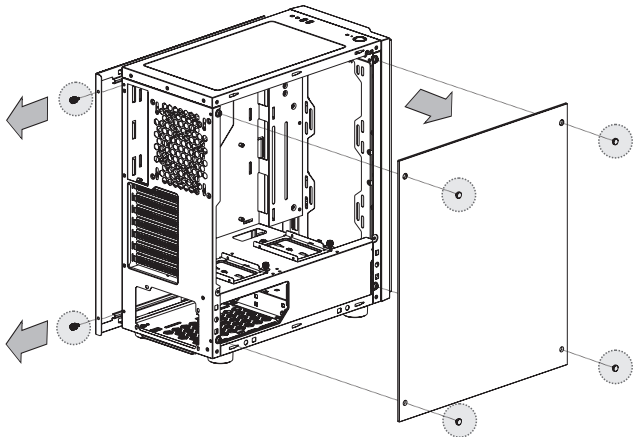

English /  
Remove the screws on the back of the chassis,  
and open the side panel.

Deutsch /  
Entfernen Sie die Schrauben auf der Rückseite  
des Gehäuses und öffnen Sie das Seitenteil.

Français /  
Enlevez les vis à l'arrière du châssis et ouvrez le  
panneau latéral.

Español /  
Extraiga los tornillos de la parte posterior de la  
caja y abra el panel lateral.

Italiano /  
Rimuovere le viti sulla parte posteriore dello  
chassis e aprire il pannello laterale.

Português /  
Remova os parafusos na parte de trás da caixa e  
abra o painel lateral.

繁體中文 /  
移除機殼後方螺絲，將側窗打開。

简体中文 /  
卸除机壳后方螺丝，将侧窗打开。

日本語 /  
シャーシ背面のねじを取り外し、サイドパネ  
ルを開きます。

Русский /  
Открутите винты на задней стенке корпуса  
и откройте боковую панель.

Türkçe /  
Kasanın arkasındaki vidaları çıkarın ve yan  
paneli açın.

ภาษาไทย /  
ถอดสกรูที่ด้านหลังของแชสซีส์  
แล้วเปิดแผงด้านข้าง

## PSU Installation

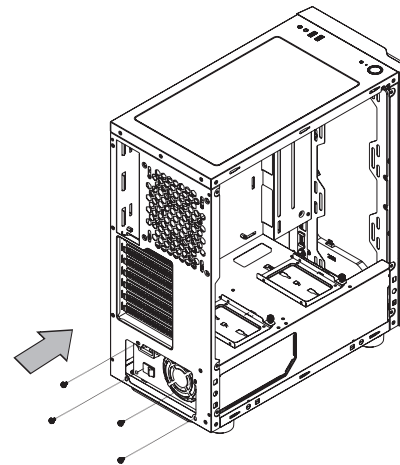

English /  
Place the power supply in proper location and  
secure it with screws.

Deutsch /  
Installieren Sie das Netzteil an seiner Position und  
sichern Sie es mit Schrauben.

Français /  
Mettez l'alimentation dans le bon endroit et  
sécurisez-la avec des vis.

Español /  
Coloque el suministro de alimentación en el lugar  
adecuado y asegúrelo con tornillos.

Italiano /  
Posizionare l'alimentatore in modo appropriato e  
fissarlo utilizzando le viti.

Português /  
Coloque a fonte de alimentação na devida  
localização e aparafuse.

繁體中文 /  
將電源供應器放在正確的位置，並用螺絲固定  
鎖上。

简体中文 /  
恰当定位电源供应器位置并以螺丝安全固定。

日本語 /  
電源装置を適切な場所に取り付け、ねじで固  
定します。

Русский /  
Установите блок питания в надлежащее  
место и закрепите его винтами.

Türkçe /  
Güç kaynağını uygun konuma yerleştirin ve  
vidalarla sabitleyin.

ภาษาไทย /  
วางแหล่งจ่ายไฟในตำแหน่งที่เหมาะสมแล้วขันสกรู  
ยึดให้แน่น

## Motherboard Installation

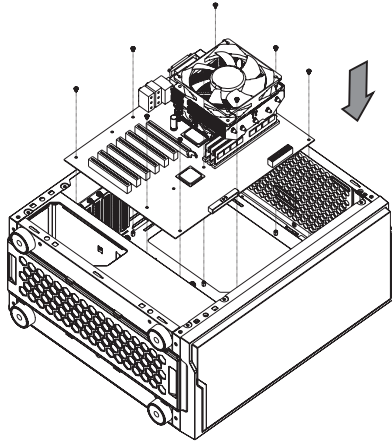

English /

- 1.Lay down the chassis.
- 2.Install the motherboard in proper location and secure it with screws.

Deutsch /

- 1.Legen Sie das Gehäuse auf die Seite.
- 2.Installieren Sie die Hauptplatine in ihrer vorgesehenen Position und sichern Sie sie mit Schrauben.

Français /

- 1.Posez à plat le châssis.
- 2.Installez la carte mère dans l'endroit approprié et sécurisez-la avec des vis.

Español /

1. Tumbé el chasis.
2. Instale la placa madre en la ubicación adecuada y asegúrela con tornillos.

Italiano /

- 1.Poggiare lo chassis.
- 2.Installare la scheda madre nella posizione appropriata e fissarla con le viti.

Português/

1. Deixe a caixa.
2. Instale a motherboard no local adequado e aparafuse.

繁體中文 /

1. 將機殼平放。
2. 將主機板放置在合適的位置並用零件包中之螺絲固定。

简体中文 /

1. 放平机箱。
2. 在合适的位置安装主板并以螺丝安全固定。

日本語 /

1. シャーシを下に置きます。
2. マザーボードを適切な場所に取り付け、ねじで固定します。

Русский /

1. Раскройте системный блок.
2. Установите материнскую плату в надлежащее место и закрепите ее винтами.

Türkçe /

- 1.Kasayı yan yatırın.
- 2.Ana kartı uygun konuma takın ve vidalarla sabitleyin.

ภาษาไทย /

- 1.วางแชสซีส์นอนลง
- 2.ติดตั้งเมนบอร์ดในตำแหน่งที่เหมาะสมแล้วขันสกรูยึดให้แน่น

## 3.5" & 2.5" HDD Installation

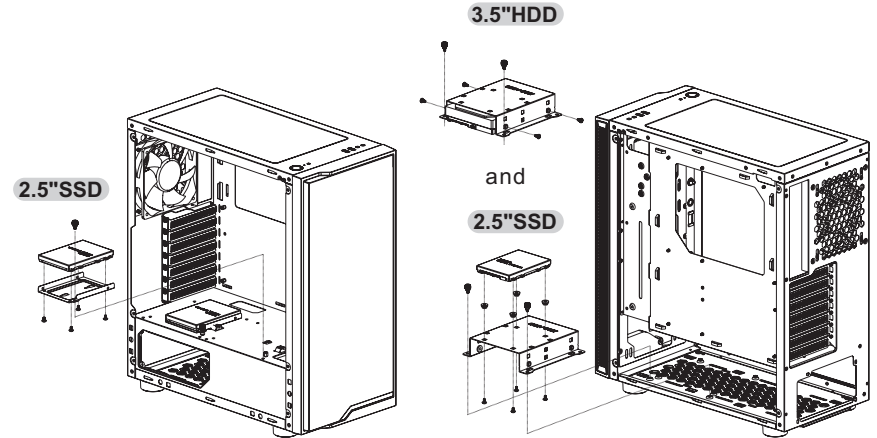

2.5"SSD

3.5"HDD

and

2.5"SSD

English /

Insert the HDD and tighten it with the screws.

Deutsch /

Führen Sie die Zoll HDD ein und befestigen Sie sie mit den Schrauben.

Français /

Insérez le disque dur de et sécurisez-le avec les vis.

Español /

Inserte el disco duro de y apriételo con los tornillos.

Italiano /

Inserire il dispositivo HDD da e fissarlo con le viti.

Português /

Insira o disco rígido de e aparafuse.

繁體中文 /

插入硬碟並用螺絲鎖上。

简体中文 /

插入硬盘并用螺丝锁上。

日本語 /

HDDを挿入し、ねじで締め付けます。

Русский /

Установите дюймовый жесткий диск и зафиксируйте его винтами.

Türkçe /

HDD'yi yerleştirin ve vidalarla sabitleyin.

ภาษาไทย /

ใส่ HDD ขนาด เข้าไปแล้วขันสกรูยึดให้แน่น



## Air Cooling Installation

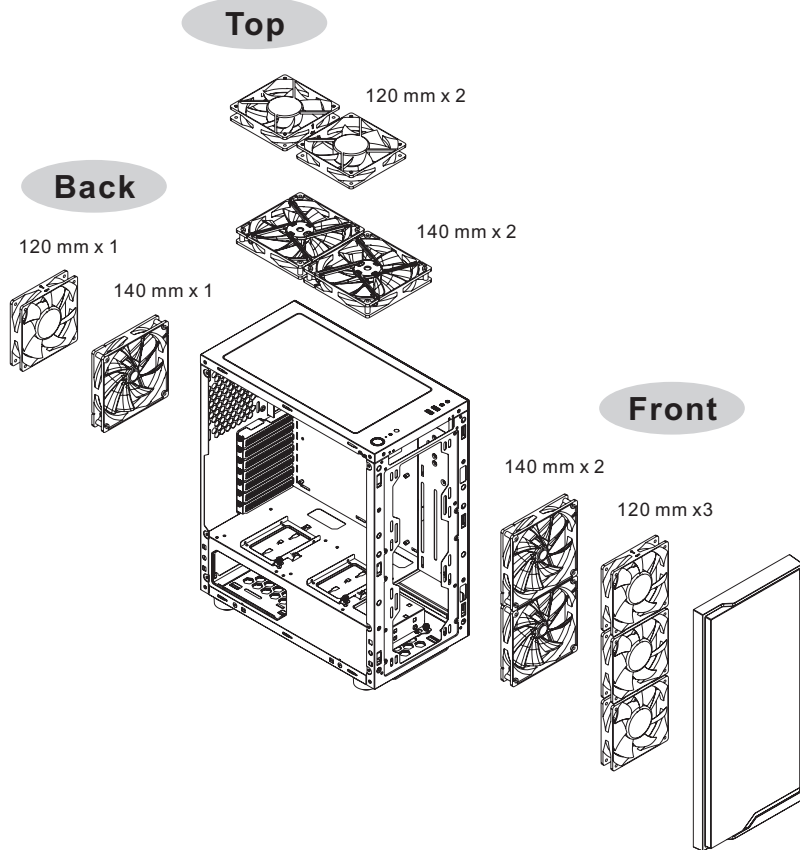

## Radiator Installation

※The radiator is applicable up to 40 mm high

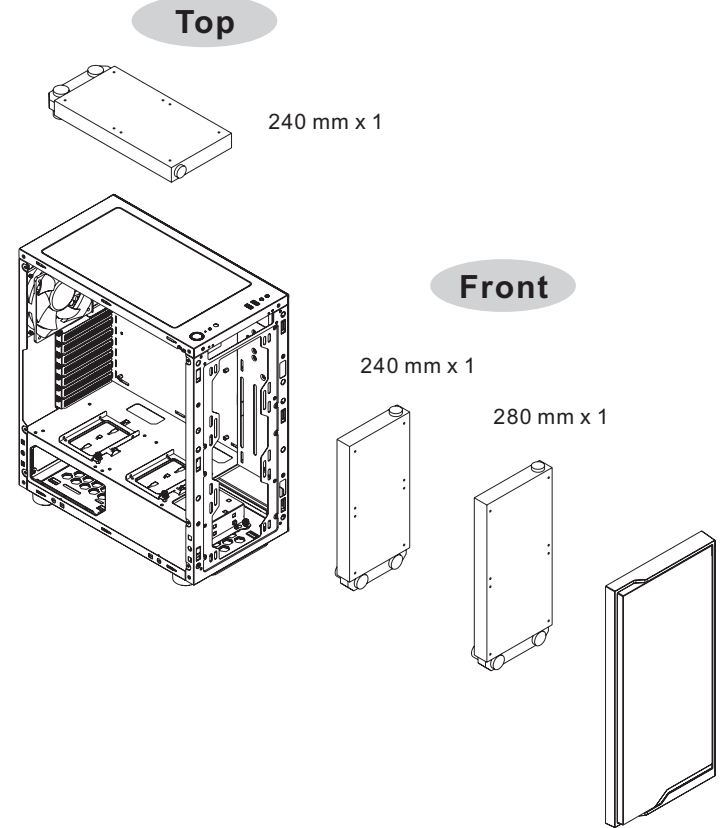



# Leads Installation

## English

### Leads Installation Guide

**A. Case LED Connection** / On the front of the case, you can find some LEDs and switch leads. Please consult your user manual of your motherboard manufacturer, then connect these leads to the panel header on the motherboard.

**B. USB 3.0 connection** /

1. Make sure your motherboard supports USB 3.0 connection.
2. Connect the USB 3.0 cable to the available USB 3.0 port on your computer.

**C. Audio Connection** / Please refer to the following illustration of Audio connector and your motherboard user manual. Please select the motherboard which used AC'97 or HD Audio(Azalia), (be aware of that your audio supports AC'97 or HD Audio (Azalia) or it will damage your device(s).

## Deutsch

### Anschlüsse herstellen

**A. Gehäuse-LED-Verbindungen** / Auf der Gehäusevorderseite finden Sie einige LEDs und Verbindungen. Bitte nehmen Sie die Gebrauchsanweisung Ihres Motherboard Herstellers zur Hilfe und schließen Sie diese Verbindungen an die Panel Header Belegung des Motherboards an.

**B. USB 3.0 Anschluss** /

1. Stellen Sie sicher, dass Ihre Hauptplatte den USB 3.0 Anschluss unterstützt.
2. Verbinden Sie das USB 3.0 Kabel mit dem USB 3.0 Port auf Ihrem Computer.

**C. Audio Anschlüsse** / Bitte beachten Sie die folgende Abbildung der Audio Anschlüsse und die Anweisung in der Gebrauchsanweisung Ihres Motherboards. Bitte wählen Sie das Motherboard, das AC'97 oder HD Audio(Azalia) verwendet, (achten Sie darauf, dass Ihr Audio AC'97 bzw. HD Audio (Azalia unterstützt)). Andernfalls entstehen schwere Schäden an Ihrem(n) Gerät(en)!!!

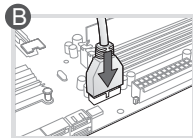
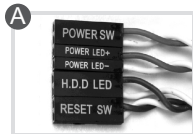

USB 3.0 Connection

**C AUDIO HD AUDIO Function**

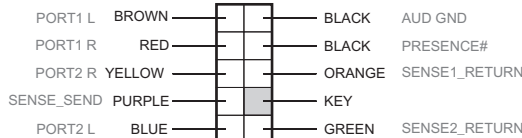

## Français

### Guide d'installation des fils

**A. Connexion des voyants du boîtier** / Sur la face avant du boîtier, vous trouverez plusieurs voyants et les fils des boutons. S'il vous plaît consultez le guide d'utilisateur du fabricant de votre carte mère, puis connectez ces fils aux connecteurs sur la carte mère.

**B. Connexion USB 3.0** /

1. Vérifiez que votre carte mère prend en charge la connexion USB 3.0.
2. Connectez le câble USB 3.0 au port USB 3.0 disponible sur votre ordinateur.

**C. Connexion Audio** / S'il vous plaît référez vous à l'illustration suivante du connecteur audio et au guide de l'utilisateur de votre carte mère. S'il vous plaît sélectionnez une carte mère supportant AC'97 ou HD Audi (Azalia), (faites attention que votre audio supporte l'AC'97 ou HD Audio (Azalia) sinon cela pourrait endommager votre matériel.

## Español

### Guía de Instalación de Cables

**A. Conexión del LED de la caja** / En la parte frontal de la caja, encontrará algunos LED y cables de interruptores. Consulte el manual del usuario del fabricante de la placa madre, a continuación conecte estos cables al conector de la placa madre.

**B. Conexión USB 3.0** /

1. Asegúrese de que la placa base admite conexión USB 3.0.
2. Conecte el cable USB 3.0 al puerto USB 3.0 disponible en el equipo.

**C. Conexión de Audio** / Consulte la siguiente ilustración del conector de Audio y el manual del usuario de la placa madre. Seleccione la placa madre que utiliza AC'97 o HD Audio (Azalia), (asegúrese de que su audio admite AC'97 o HD Audio (Azalia) si no, sus dispositivos resultarán dañados

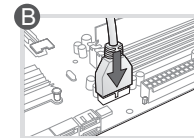

USB 3.0 Connection

**C AUDIO HD AUDIO Function**

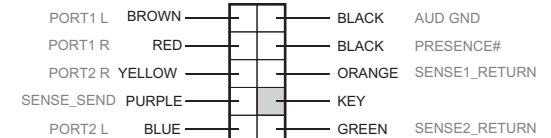

## Italiano

### Guida di installazione dei contatti

**A. Connessione del LED del case** / Nella parte anteriore del case, sono presenti alcuni contatti per interruttori e LED. Consultare il manuale utente del produttore della scheda madre, quindi connettere i contatti alla parte superiore del pannello sulla scheda madre.

**B. Connessione USB 3.0** /

1. Accertarsi che la scheda madre supporti la connessione USB 3.0.
2. Collegare il cavo USB 3.0 alla porta USB 3.0 disponibile sul computer.

**C. Connessione Audio** / Fare riferimento all'illustrazione riportata di seguito del connettore Audio e al manuale utente per la scheda madre. Selezionare la scheda madre relativa a AC'97 o HD Audio (Azalia) e considerare che il supporto audio è compatibile con AC'97 o HD Audio (Azalia); in caso contrario, le periferiche potrebbero venire danneggiate.

## Português

### Guia de Instalação Eléctrica

**A. Ligação do LED da Caixa** / Na parte dianteira da caixa pode encontrar alguns LEDs e fios eléctricos. Consulte o manual de utilizador do fabricante da sua motherboard e ligue os fios à parte superior do painel na motherboard.

**B. Ligação USB 3.0** /

1. Certifique-se que a sua motherboard suporta ligação USB 3.0.
2. Ligue o cabo USB 3.0 à porta USB 3.0 disponível no seu computador.

**C. Ligação Áudio** / Consulte a imagem seguinte do conector Áudio e o manual de utilizador da sua motherboard.

Selecione a motherboard que utiliza AC'97 ou HD Áudio (Azalia), (verifique se a sua placa de áudio suporta AC'97 ou HD Áudio (Azalia)) ou irá danificar o(s) seu(s) dispositivo(s).

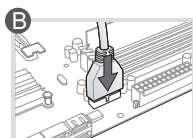
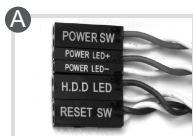

USB 3.0 Connection

**C AUDIO HD AUDIO Function**

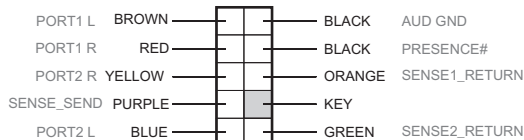

## 繁體中文

### 線材安裝說明

**A. 機殼LED連接方式** / 在機殼前方的面板後面，可以找到一些LED與開關線材 (POWER Switch....)，請參考主機板使用說明書，並將機殼上的線材正確地連接到主機板上，這些線材通常都會印有標籤在上面，如果沒有的話，請找出機殼前方面板上線材原本的位置以知道正確的來源。

**B. USB 3.0 連接 /**

1. 請確認主機板是否支援USB 3.0傳輸介面。
2. 連接USB 3.0傳輸線至主機板上的USB3.0接埠。

**C. 音效連接** / 請根據下面的音源接頭圖示與主機板使用手冊來連接音效裝置，請確認主機板上的音效裝置是支援AC'97音效或是HD音效(Azalia)，裝置錯誤可能會導致主機板音效裝置的毀損，某些主機板的音效裝置不會與下方的圖示完全相同，請參酌主機板使用手冊以得到正確的安裝資訊

## 简体中文

### 线材安装说明

**A. 机壳LED连接方式** / 在机壳前方的面板后面，可以找到一些LED与开关线材 (POWER Switch....)，请参考主板使用说明书，并将机壳上的线材正确地连接到主板上，这些线材通常都会印有标签在上面，如果没有的话，请找出机壳前方面板上线材原本的位置以知道正确的来源。

**B. USB 3.0 连接 /**

1. 请确认主板是否支持USB 3.0传输接口。
2. 连接USB 3.0传输线至主板上的USB3.0接埠。

**音效连接** / 请根据下面的音源接头图示与主板使用手册来连接音效装置，请确认主板上的音效装置是支持AC'97音效或是

HD音效(Azalia)，装置错误可能会导致主板音效装置的毁损，某些主板的音效装置不会与下方的图标完全相同，请参酌主板使用手册以得到正确的安装信息

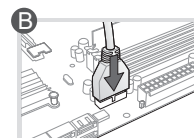
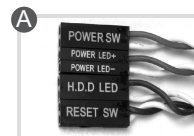

USB 3.0 Connection

**C AUDIO HD AUDIO Function**

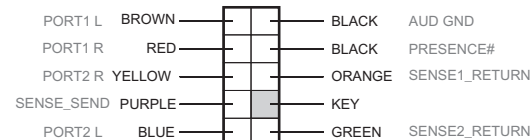

## 日本語

### リード線の取り付けガイド

A. ケース LED の接続 / ケース前面には、LEDとスイッチリード線があります。 マザーボードメーカーのユーザーマニュアルを参照し、これらのリード線をマザーボードのパネルヘッダに接続してください。

B. USB 3.0 の接続 /

1. お使いのマザーボードがUSB 3.0接続をサポートしていることを確認してください。
2. USB 3.0ケーブルをコンピュータの空いているUSB 3.0ポートに接続します。

C. オーディオ接続 / オーディオコネクタの次の図とマザーボードのユーザーマニュアルを参照してください。AC'97またはHDオーディオ(Azalia)を使用するマザーボードを選択してください(オーディオがAC'97またはHDオーディオ(Azalia)をサポートしていることを確認してください)。サポートしていないと、デバイスが損傷します)。

## Русский

### Указания по прокладке кабелей

A. Подключение индикаторов корпуса / В передней части корпуса расположены индикаторы и провода выключателей. Перед подсоединением этих проводов к монтажной колодке панели на материнской плате изучите руководство пользователя производителя материнской платы.

B. Подключение USB 3.0 /

1. Убедитесь, что материнская плата поддерживает подключение по стандарту USB 3.0.
2. Подсоедините кабель USB 3.0 к свободному порту USB 3.0 компьютера.

C. Подключение аудиоразъема / См. следующую иллюстрацию аудиоразъема и руководство пользователя материнской платы. Выберите материнскую плату, в которой используется кодек AC'97 или HD Audio (Azalia) (убедитесь, что звуковая плата поддерживает кодек AC'97 или HD Audio (Azalia)). В противном случае можно повредить устройства.

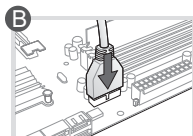
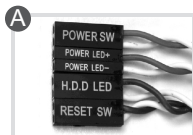

USB 3.0 Connection

### C AUDIO HD AUDIO Function

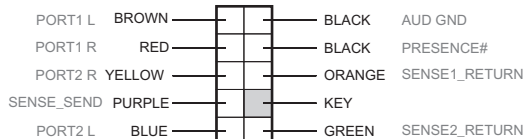

## Türkçe

### Ara Kablo Kurulum Kılavuzu

A. Kasa ışık bağlantısı / Kasanın ön kısmında bazı ışıklar ve anahtar ara kabloları görebilirsiniz. Lütfen anakart üreticinizin sağladığı kullanım kılavuzuna bakın ve daha sonra, bu ara kabloları, anakart üzerindeki panel bağlantı noktalarına bağlayın.

B. USB 3.0 Bağlantısı /

1. Ana kartınızın USB 3.0 bağlantısını desteklediğinden emin olun.
2. USB 3.0 kablousunu, bilgisayarınızdaki kullanılabilir USB 3.0 bağlantı noktasına bağlayın.

C. Ses Bağlantısı / Lütfen aşağıdaki Ses konektörü resmine ve anakartınızın kullanım kılavuzuna bakın. Lütfen AC'97 veya HD Audio(Azalia) spesifikasyonunu kullanan bir anakart seçin (ses sisteminizin AC'97 veya HD Audio (Azalia) spesifikasyonunu desteklediğini unutmayın); aksi takdirde, aygıt(lar)ınız zarar görür.

## ภาษาไทย

### คู่มือการติดตั้งสายไฟ

A. การเชื่อมต่อไฟ LED ของเคส / ที่ด้านหน้าของเคส คุณจะเห็นไฟ LED และสายไฟของสวิตช์ กรณีศึกษารายละเอียดจากคู่มือผู้ใช้ของผู้ผลิตแผงวงจรหลักของคุณ จากนั้นให้เชื่อมต่อสายไฟเหล่านี้เข้ากับส่วนหัวของแผงบนแผงวงจรหลัก

B. การเชื่อมต่อ USB 3.0 /

1. ตรวจสอบให้แน่ใจว่าแผงวงจรหลักของคุณรองรับการเชื่อมต่อ USB 3.0
2. เชื่อมต่อสาย USB 3.0 เข้ากับพอร์ต USB 3.0 ที่สามารถใช้งานได้บนคอมพิวเตอร์ของคุณ

C. การเชื่อมต่ออุปกรณ์รับส่งสัญญาณเสียง / กรุณาดูรายละเอียดจากภาพประกอบของตัวเชื่อมต่อสัญญาณเสียงต่อไปนี้ และคู่มือผู้ใช้ของผู้ผลิตแผงวงจรหลักของคุณ

กรุณาเลือกแผงวงจรหลักที่ใช้ AC'97 หรือ HD Audio(Azalia)

(กรุณาตรวจสอบให้แน่ใจว่าอุปกรณ์รับส่งสัญญาณเสียงของคุณรองรับ AC'97 หรือ HD Audio (Azalia))

มิฉะนั้นอุปกรณ์ของคุณอาจเสียหายได้

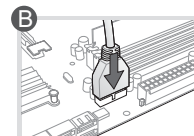

USB 3.0 Connection

### C AUDIO HD AUDIO Function

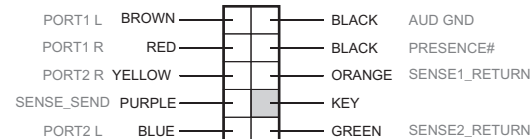

## Thermaltake Power Supply Series (Optional)



### What is Smart Power Management (SPM)?

Smart Power Management (SPM) is a cloud-based software that seamlessly integrates three intelligent platforms – DPS G PC APP 3.0, DPS G Smart Power Management Cloud 1.0 and DPS G Mobile APP 1.0 – and compiles key statistics about your PC into detailed charts and breakdowns for your instant PC status view and management. With easy access to SPM through your PC or mobile devices, whether you are outside or indoors, enjoy taking full control of your build anytime, anywhere!



Thermaltake has several power supply product lines; please refer to our official website and Facebook Fan Page for more detail information!

**Brand official website:**

<http://www.thermaltake.com/>

**Global Facebook :**

<https://www.facebook.com/ThermaltakeInc>

**Taiwan Facebook**

<https://www.facebook.com/ThermaltakeTW>



## Tt RGB Plus Ecosystem



**Tt RGB Plus Software**  
Thermaltake's patented software to synchronize TT RGB PLUS products with addressable LEDs.



**Tt AI Voice Control**  
Give you full control over the TT RGB PLUS products with your voice.

### SyncALL, Say "Hello TT"



Download on the App Store



GET IT ON Google play



Learn more about TT RGB Plus