

EN Welcome, Get started! **AZ** Xoş gəldiniz, başlayın! **BG** Добре дошли, да започваме! **CS** Víťame vás veľmi srdečne! **DA** Velkommen, kom godt i gang! **DE** Willkommen! Lesen Sie los! **EL** Καλωσήρθατε, ας ξεκινήσουμε! **ES** ¡Hola, empecemos! **ES-MX** Bienvenido, ¡empieza! **ET** Tere tulemast, alustage! **FI** Tervetuloa, aloitetaan! **FR** Bienvenue, débutez! **FR-CA** Bienvenue, commencez! **HR** Dobro došli, započnite! **HU** Üdvözlünk! Kezdjünk is hozzá! **HY** Բարի գալուստ, սկսվեք: **ID** Selamat datang, silakan memulai! **IT** Ti diamo il benvenuto. Iniziamo! **KA** მგობრსაღმებნის, დანბყთ მუბამბა! **KK** Қош келдіңіз, ал бастайық! **KO** 환영합니다. 지금 시작하세요! **KY** Кош келиңиз, баштадык! **LT** Sveiki, pradėkite naudoti! **LV** Laipni lūgti, viss gatavs lietošanai! **MK** Добре дојдовте, започнете со употреба! **MS-MY** Selamat datang, mari bermula! **NL** Welkom, aan de slag! **NO** Velkommen, kom i gang! **PL** Witaj, zacznijmy! **PT** Bem-vindo, vamos começar! **PT-BR** Bem-vindo(a)! Comece! **RO** Bine ai venit, începe! **RU** Добро пожаловать, приступим! **SK** Vitajte, začíname! **SL** Dobrodošli, začnite! **SQ** Mirë se vini, fillojmë! **SR** Dobro došli, započnite! **SV** Välkommen. Nu sätter vi igång! **TG** Хуш омадед, оғоз кунед! **TH** ยินดีด้วย เริ่มใช้งานได้เลย! **TK** Hoş geldiniz, başlayın! **TR** Hoş geldiniz, haydi başlayalım! **UK** Вітаємо, розпочнімо! **UZ** Xush kelibsiz, boshlang! **VI** Chào mừng, bắt đầu! **SC** 欢迎您，让我们开始吧! **TC** 歡迎，馬上開始! **FA** خوش آمدید، شروع کنید! **AR** أهلاً بك، تفضل وابدأ الاستخدام!

EN Registration and Benefits **AZ** Qeydiyyat və Üstünlüklər **BG** Регистрация и предимства **CS** Registrace a výhody **DA** Registrering og fordele **DE** Registrierung und Vorteile **EL** Δήλωση και πλεονεκτήματα **ES** Registro y ventajas **ES-MX** Registro y beneficios **ET** Registreerimine ja eelised **FI** Rekisteröinti ja edut **FR** Enregistrement et avantages **FR-CA** Inscription et avantages **HR** Registracija i prednosti **HU** Regisztráció és előnyök **HY** Գրանցում և արտոնություններ **ID** Pendaftaran dan Manfaat **IT** Registrazione e vantaggi **KA** რეგისტრაცია და უპირატესობები **KK** Тиркелу және артықшылықтар **KO** 등록 및 혜택 **KY** Каттоо жана пайдалар **LT** Registracija ir privalumai **LV** Reģistrācija un priekšrocības **MK** Регистрација и повоности **MS-MY** Pendaftaran dan Manfaat **NL** Registratie en voordelen **NO** Registrering og fordeler **PL** Rejestracja i korzyści **PT** Registo e vantagens **PT-BR** Registo e benefícios **RO** Înregistrare și beneficii **RU** Регистрация и преимущества **SK** Registrácia a výhody **SL** Registracija in ugodnosti **SQ** Regjistrimi dhe përfitimet **SR** Registracija i prednosti **SV** Registrering och fördelar **TG** Бақайдырың ва имтиёзхор **TH** การลงทะเบียนและผลประโยชน์ **TK** Bəlligə alyş we peýdalary **TR** Kayıt ve Avantajlar **UK** Реєстрація та переваги **UZ** Ro'yxatdan o'tish va imtiyozlar **VI** Đăng ký và lợi ích **SC** 注册和权益册 **TC** 註冊與權益 **FA** ثبتنام و فواید آن **AR** التسجيل والمزايا

EN Digital manual **AZ** Rəqəmsal təlimat kitabçası **BG** Дигитално ръководство **CS** Digitální příručka **DA** Digital manual **DE** Digitales Handbuch **EL** Ψηφιακό εγχειρίδιο **ES** Manual digital **ES-MX** Manual digital **ET** Digitaalne kasutusjuhend **FI** Digitaalinen käyttöopas **FR** Manuel numérique **FR-CA** Manuel numérique **HR** Digitalni priručnik **HU** Digitális kézikönyv **HY** Թվային ձեռնարկ **ID** Manual digital **IT** Manuale digitale **KA** ციფრული სახელმძღვანელო **KK** Цифрлық нұсқаулық **KO** 디지털 설명서 **KY** Санариптик, кол менен **LT** Skaitmeninis vadovas **LV** Digitālā rokasgrāmata **MK** Дигитално упатство **MS-MY** Manual digital **NL** Digitale handleiding **NO** Digital håndbok **PL** Elektroniczna instrukcja obsługi **PT** Manual digital **PT-BR** Manual digital **RO** Manual digital **RU** Цифровое руководство **SK** Digitálna príručka **SL** Digitalni priročnik **SQ** Manuali digjital **SR** Digitalno uputstvo **SV** Digital användarhandbok **TG** Роҳнамои рақамӣ **TH** คู่มือการใช้งาน **TK** Sanly gollanma **TR** Dijital kılavuz **UK** Цифровий посібник **UZ** Raqamli qo'llanma **VI** Hướng dẫn kỹ thuật số **SC** 数字手册 **TC** 數位手冊 **FA** راهنمای دیجیتال **AR** الدليل الرقمي

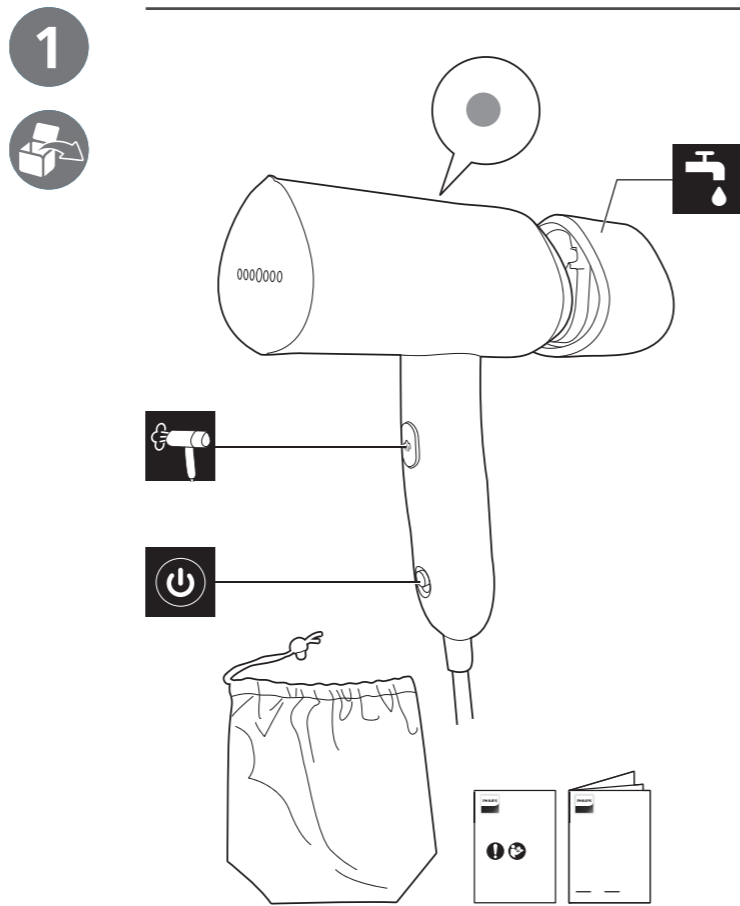

STH3010, STH3014
STH3020, STH3024

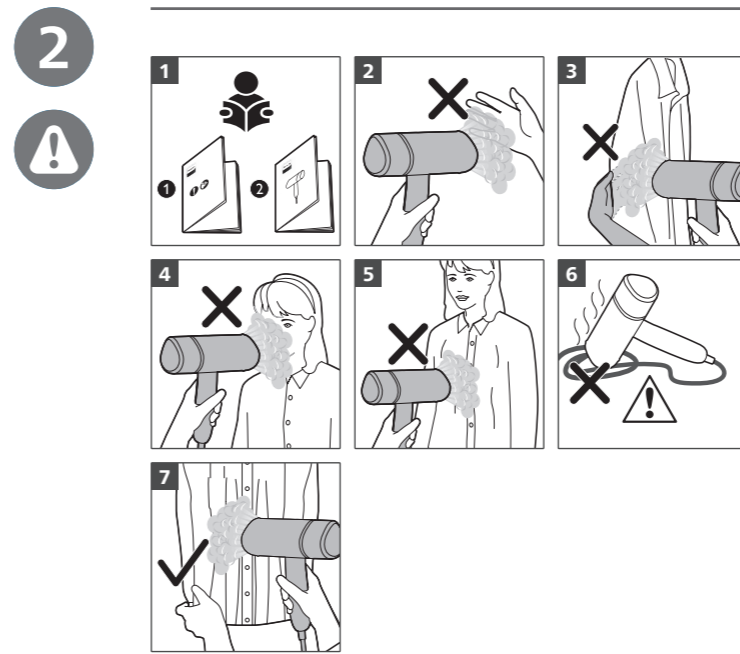

PHILIPS
3000 Series
STH3000, STH3020

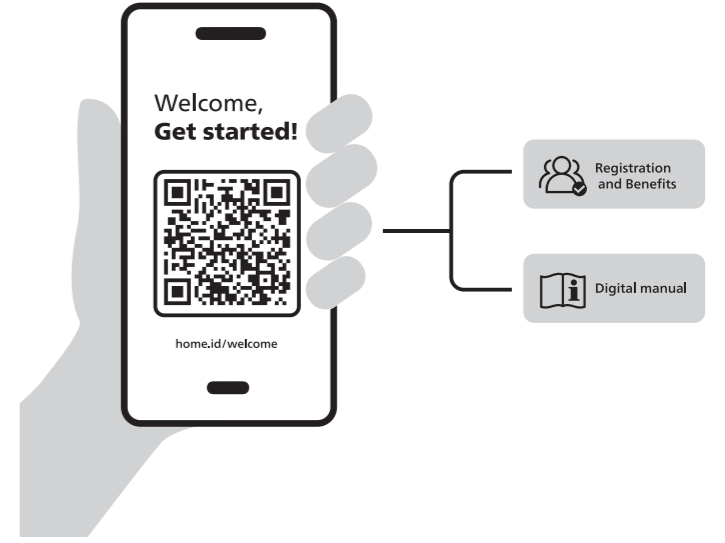

PHILIPS and the Philips Shield Emblem are registered trademarks of Koninklijke Philips N.V. and are used under license. This product has been manufactured by and is sold under the responsibility of Versuni Holding B.V., and Versuni Holding B.V. is the warrantor in relation to this product. 2023 © Versuni Holding B.V. 642001005888 (29/12/2023)



3

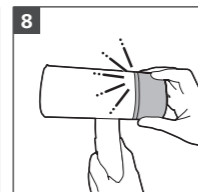
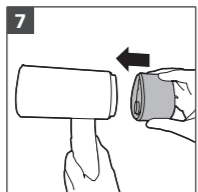
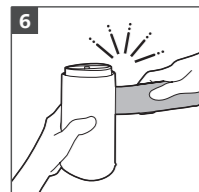
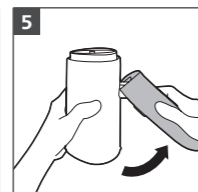
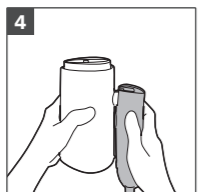
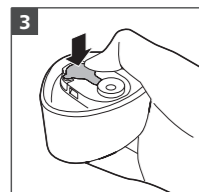
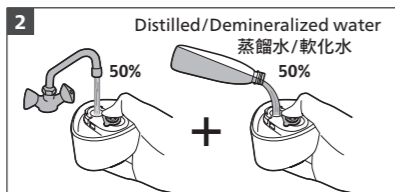
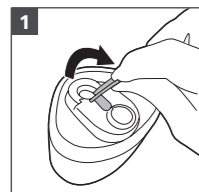
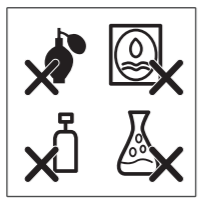
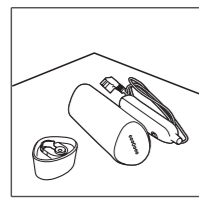

4

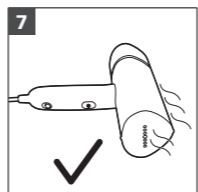
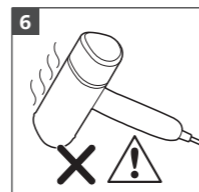
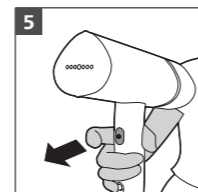
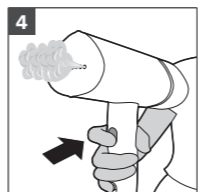
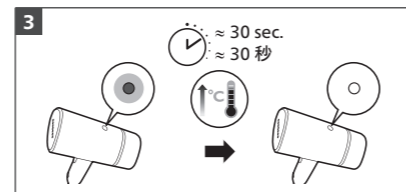
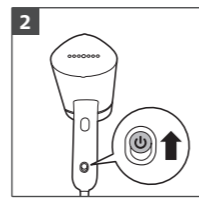
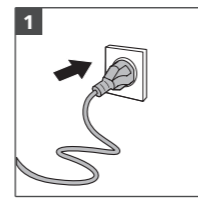

5

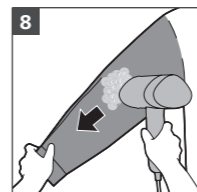
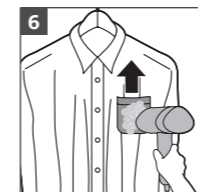
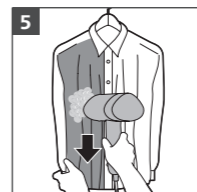
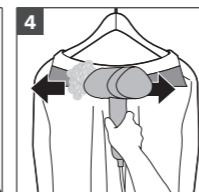
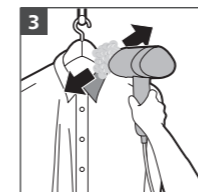
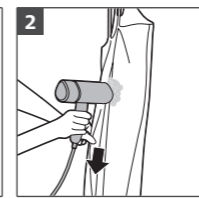
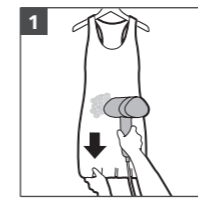

6

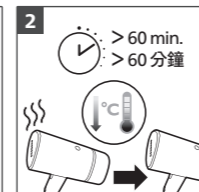
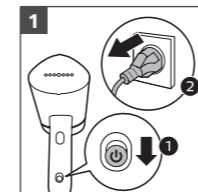

6

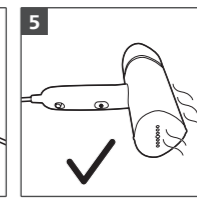
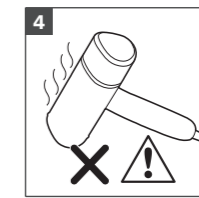

7

